





LOWER ENGINE PROTECTION MT-07 (2025)

Posnr.	QTY	
①	2	 M8x35
②	2	 M8
③	2	 Ø12.8xØ8.6x20
④	4	 M10x30
⑤	1	
⑥	1	
⑦	1	
⑧	1	



Easy, suitable for novice with little experience

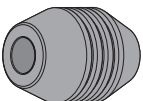
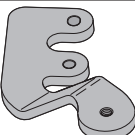
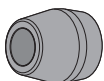
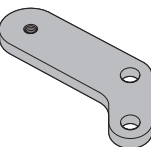
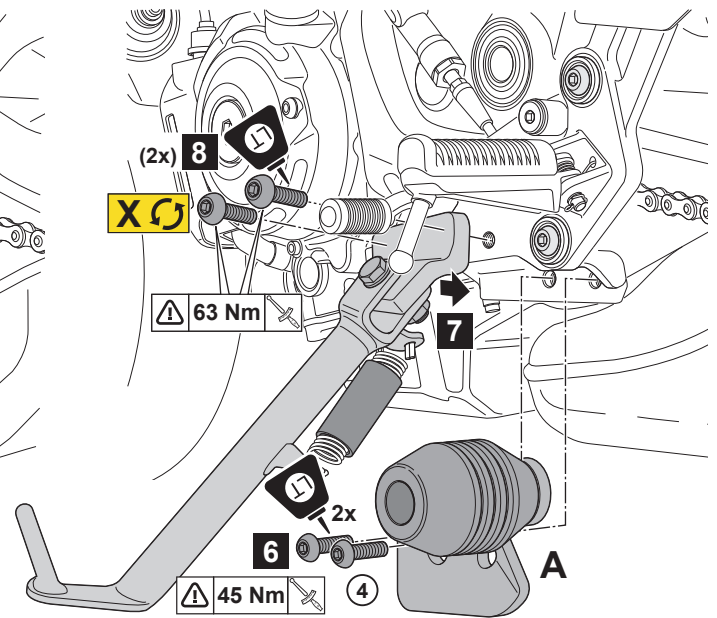
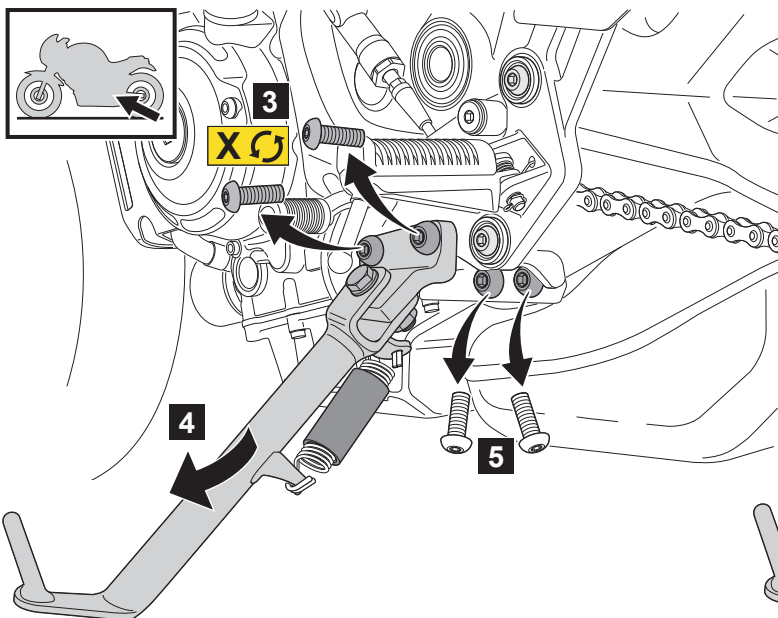
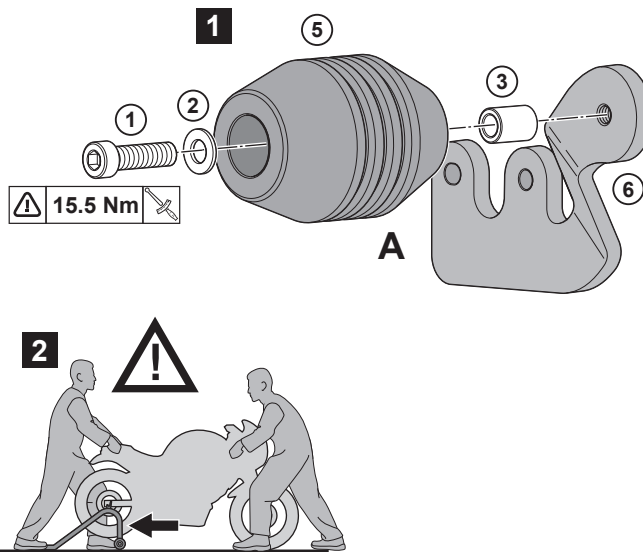

Fairly easy, suitable for beginner with some experience



Fairly difficult, suitable for competent DIY mechanic



Difficult, suitable for experienced DIY mechanic



Very difficult, suitable for expert DIY or professional



LOWER ENGINE PROTECTION MT-07 (2025)

